

2-Wire VTO2000A-2 User's Manual

2-Wire VTO2000A-2
User's Manual

V1.0.0

1.2.51.18.11090-000

Table of Contents

1 Product Overview	03
1.1 List of Models	03
1.2 Structure.....	03
1.2.1 Dimension	03
1.2.2 Front Panel.....	04
1.2.3 Rear Panel	04
1.3 System Networking	05
1.3.1 One-to-One Scene.....	05
1.3.2 Group Call Scene.....	05
2 Install VTO	07
2.1 Direct Installation	07
2.1.1 Screw	07
2.1.2 Dimension	07
2.1.3 Installation Step	08
2.2 Embedded in Wall	09
2.2.1 Screw	09
2.2.2 Dimension.....	09
2.2.3 Installation Step	09
2.3 Wiring	11
2.4 Electric Control Lock and Electromagnetic Lock	12
2.4.1 Electric Control Lock.....	12
2.4.2 Electromagnetic Lock.....	12
3 Installation Debugging	14
3.1 WEB Setup	14
3.2 General Config.....	15
4 Web Config	17
4.1 System Config.....	17
4.1.1 Local Config	17
4.1.2 LAN Config	18
4.1.3 Indoor Manager.....	18
4.1.4 Network Config	19
4.1.5 Video Set	19
4.1.6 User Manage	20
4.2 Info Search	21
4.2.1 Call History	21
4.2.2 Alarm Record	21
4.3 Status Statistics	22
4.3.1 VTH Status	22
4.4 Logout.....	22
5 Basic Function Introduction	23
5.1 Call Function.....	23
5.1.1 Call Manager Center	23
5.1.2 Call User	23
5.1.3 Group Call.....	24
5.2 Monitor.....	27
5.3 Unlock Function.....	27
5.4 Compensation of Light.....	27
5.5 Vandal Proof.....	27
5.6 Restore Backup.....	27
6 FAQ	28
Appendix 1 Technical Specifications	29
Appendix 2 Technical Specifications	30
Appendix 2.1 Cable Specification.....	30
Appendix 2.2 Power Extension Line Specification.....	30
Appendix 2.3 Embedded Box	30
Appendix 3 VTMS	31
Appendix 4 VTMS Client	33
Appendix 4.1 Config Network Address.....	33
Appendix 4.2 Create Organization	35
Appendix 5 Toxic or Hazardous Materials or Elements	37

Important Safeguards and Warnings

Thank Please read the following safeguards and warnings carefully before using the product in order to avoid damages and losses.

Note:

- Do not expose the device to lampblack, steam or dust. Otherwise it may cause fire or electric shock.
- Do not install the device at position exposed to sunlight or in high temperature. Temperature rise in device may cause fire.
- Do not expose the device to humid environment. Otherwise it may cause fire.
- The device must be installed on solid and flat surface in order to guarantee safety under load and earthquake. Otherwise, it may cause device to fall off or turnover.
- Do not place the device on carpet or quilt.
- Do not block air vent of the device or ventilation around the device. Otherwise, temperature in device will rise and may cause fire.
- Do not place any object on the device.
- Do not disassemble the device without professional instruction.

Warning:

- Please use battery properly to avoid fire, explosion and other dangers.
- Please replace used battery with battery of the same type.
- Do not use power line other than the one specified. Please use it properly. Otherwise, it may cause fire or electric shock.

Special Announcement

- This manual is for reference only.
- All the designs and software here are subject to change without prior written notice.
- All trademarks and registered trademarks are the properties of their respective owners.
- If there is any uncertainty or controversy, please refer to the final explanation of us.
- Please visit our website for more information.

1 Product Overview

1.1 List of Models

Model	Chassis Material	Color	Unlock via IC card	Button Type	Lock Control Module
VTO2000A-2	Metal	Silver	N/A	Mechanical key	Built-in

1.2 Structure

1.2.1 Dimension

Before you install the device, please make sure you know the dimension of device and select appropriate installation method. See Figure 1 – 1.

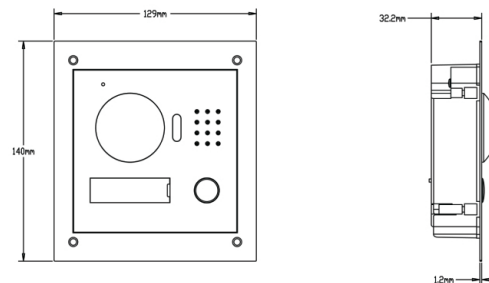

Figure 1 – 1

1.2.2 Front Panel

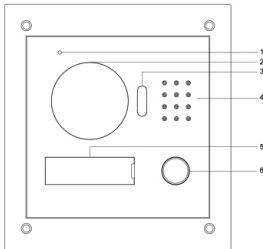

Figure 1–2

No.	Port Name	Note
1	MIC	Audio input.
2	Camera	It monitors corresponding door region.
3	Compensation Light	Light compensation will automatically turn on during monitoring, calling, or connecting status if there is no enough light in environment.
4	Speaker	Audio output.
5	User Nameplate	Display username and other info.
6	Call Button	Call center or VTH.

1.2.3 Rear Panel

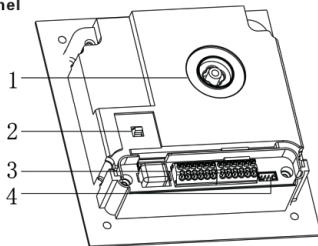

Figure 1–3

No.	Component Name	Note
1	Camera Angle Adjustment	Adjust camera angle.
2	Vandal–proof Switch	When VTO is forced to leave wall, it will alarm and report to MGT center.
3	User Port	Connect to lock, door sensor feedback and unlock button.
4	Project Port	Reserved for project staff use.

1.3 System Networking

This chapter mainly introduces usage of digital VTO, please read the following content and install the device according to your actual condition.

1.3.1 One-to-One Scene

Visitor press Call button to call residence (as VTH) or Center. See Figure 1–4.

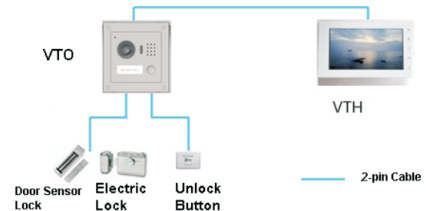

Figure 1–4

1.3.2 Group Call Scene

When visitor press Call button on VTO, multiple VTHs will ring at the same time. User can call, hang up, and unlock on any of these VTHs.

Note:

VTH has 1 master VTH and up to 3 extension VTHs. See Figure 1–5.

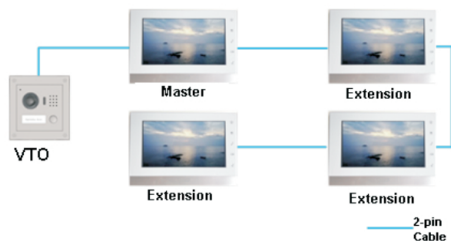

Figure 1- 5

2 Install VTO

2.1 Direct Installation

2.1.1 Screw

Before installing VTH, please check screws on accessory bag according to the following specifications and install by following this guide.

Component Name	Illustration	Quantity
M3 × 6 Hex slot pan head tail machine screws --- galvanizing white		4
M3 × 8 Cross recessed countersunk head tail machine screws --- galvanizing white		4
ST3 × 18 Cross recessed countersunk head tail tapping screws --- galvanizing white		4
White expansion tube ϕ 6 × 30mm		4

Chart 2- 1

Note:

M3x6 or M3x8 either is OK.

2.1.2 Dimension

Before you install the device, please make sure you know the dimension of device and select appropriate installation method. See Figure 2- 1.

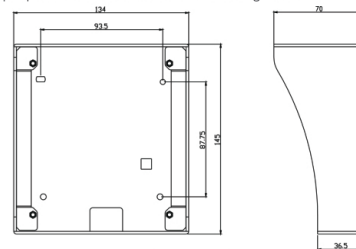

Figure 2- 1

2.1.3 Installation Step

- Step 1** Install metal bracket into the groove on wall. At spot 1 fasten screw (ST3 x 18 Cross recessed countersunk head tail tapping screws --- galvanizing white), and fix metal bracket on wall. See Figure 2-2
- Step 2** Align the device on metal bracket according to screw hole. At spot 2 fasten screw (M3 x 8 Cross recessed countersunk head tail machine screws --- galvanizing white), and fix device on metal bracket. See Figure 2-3.

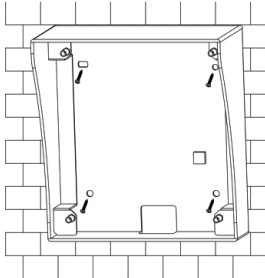

Figure 2-2

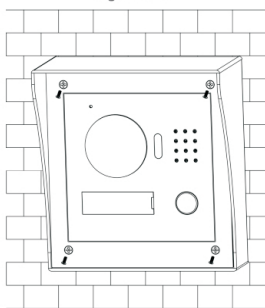

Figure 2-3

2.2 Embedded in Wall

2.2.1 Screw

Before installing VTH, please check screws on accessory bag according to the following specifications and install by following this guide.



Component	Illustration	Quantity
M3 x 6 Hex slot pan head tail machine screws --- galvanizing white		4
M3 x 8 Cross recessed countersunk head tail machine screws --- galvanizing white		4

Chart 2-2

Note:

M3x6 or M3x8 either is OK.

2.2.2 Dimension

Before you install the device, please make sure you know the dimension of device and select appropriate installation method. See Figure 2-4.

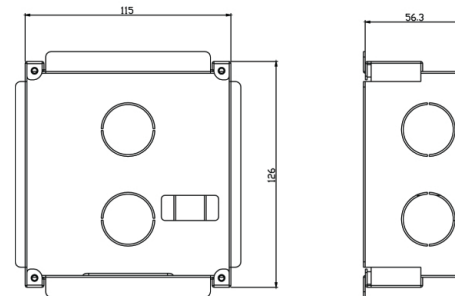

Figure 2-4

2.2.3 Installation Step

- Step 1** Dig a hole on wall, its dimension is 117*128*80(mm). See Figure 2-5.
- Step 2** Embed metal bracket into wall until its four peaks lean against the wall. See Figure 2-6.

Step 3 Align the device on metal bracket according to screw hole. At 2 spots fasten screws (M3 × 8 Cross recessed countersunk head tail machine screws --- galvanizing white), and fix device on metal bracket. See Figure 2- 7.

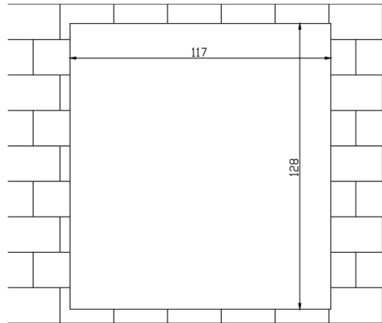

Figure 2-5

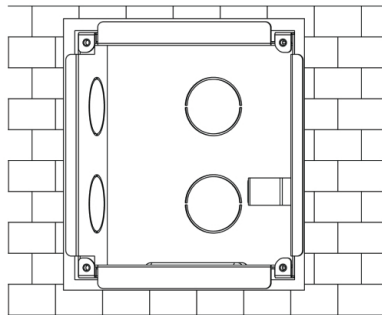

Figure 2-6

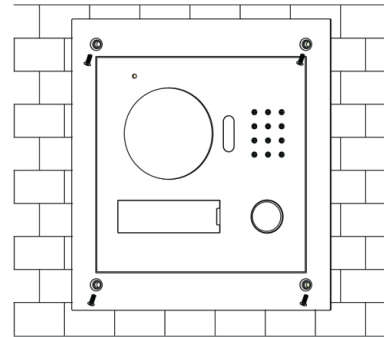

Figure 2-7

2.3 Wiring

See Figure 2- 8.

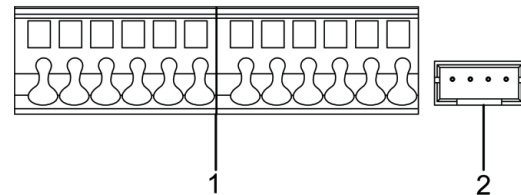

Figure 2-8

No.	Component Name	Note
1	User Port	Power supply, connect to lock, door sensor and unlock button.
2	Project Port	Reserved for project staff use.

2.4 Electric Control Lock and Electromagnetic Lock

2.4.1 Electric Control Lock

When VTO connects to electric control lock, it means that the positive end of electronic control lock connects to NO of VTO (user port 10) while its negative end connects to COM of VTO (user port 12).

When VTO connects to unlock button, one end of unlock button connects to UNLOCK BUTTON of VTO (user port 7) while the other end connects to GND of VTO (user port 9). See Figure 2–9.

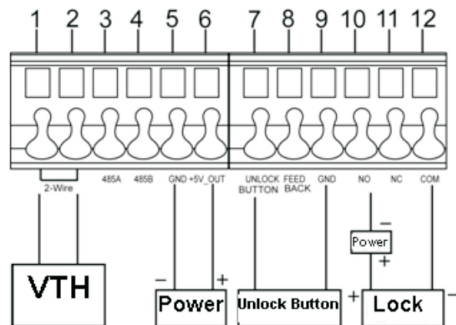

Figure 2–9

2.4.2 Electromagnetic Lock

When VTO connects to electromagnetic lock, it means that the positive end of electromagnetic lock connects to NC of VTO (user port 11) while its negative end connects to COM of VTO (user port 12).

When VTO connects to door sensor in electromagnetic lock, one end of door sensor connects to FEEDBACK of VTO (user port 8) while the other end connects to GND of VTO (user port 9). See Figure 2–10.

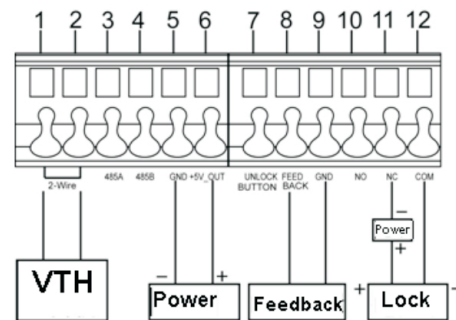

Figure 2–10

3 Installation Debugging

Warning:

- Before debugging, the staff shall be familiar with device's installation, wiring and usage.
- Before debugging, check wiring for short or open circuit.
- When staff find each circuit is normal, plug the device to power.
- After debugging, clear the site.

3.1 WEB Setup

If you first use VTO, you may need to operate according to the following steps:

- Step 1** First, make sure your PC and the VTO are well connected, and follow steps below to login WEB interface.
- Step 2** In Internet Explorer, input IP address of the VTO, and press Enter. System shows Figure 3-1.
- Step 3** Input Username and Password.
- Step 4** Click on Login.

Note:

Default IP address of VTO is 192.168.1.110. Default username and password is admin/admin. After first login, please change your password.

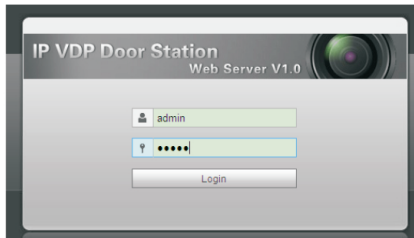

Figure 3-1

3.2 General Config

If you first use VTO, you may need to operate according to the following steps:

- Step 1** In Internet Explorer, input IP address of the VTO, and press Enter.

Note:

Default IP address of VTO is 192.168.1.110. Default username and password is admin/admin. After first login, please change your password.

- Step 2** In WEB interface, select System Config>Local Config, set video format as WVGA as in Figure 3-2.

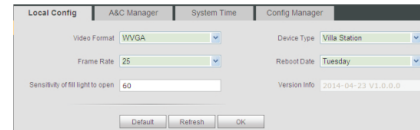

Figure 3-2

- Step 3** In System Time tab, click on Sync PC to make VTO time the same with PC.
- Step 4** Select System Config>Network Config, set VTO IP, Subnet Mask and Default Gateway. See Figure 3-3.

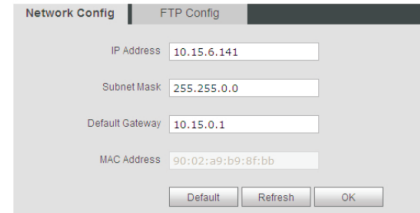

Figure 3-3

- Step 5** (Optional) If VTO connects to VTMS platform, System Config>LAN Config, set Area No. Section No. Building No. and etc. These parameters must match settings on VTMS Client. Please refer to Appendix 2 and 3. See Figure 3-4.

LAN Config

Building No.

Building Unit No.

VTO No. Group Call

Figure 3-4

Add device

SN:

Name:

Type: =VTO ty

Manufacturer:

Position:
 6901

Net Address: ...

Sub Net: ...

Gate Way: ...

Net Port:

Switch:

Recieve Notice:

Comments:

Type & location can't be changed after saving!

Figure 3-5

Note:

When you configure one-to-multiple scene, different VTOs shall have different VTO no., and same building no. and unit no., in order to form a proper network.

4 Web Config

This chapter introduces VTO WEB interface and its parameters, and how to configure them.

4.1 System Config

4.1.1 Local Config

4.1.1.1 Local Config

In Local Config interface, you can view VTO model, version info and etc.

System Config | Local Config | AAC Manager | System Time | Config Manager

Local Config

Video Format: Device Type:

Frame Rate: Reboot Date:

Sensitivity of fill light to open: Version Info:

Figure 4-1

Parameter	Note
Video Format	Set video format that collected by the camera, including: WVGA and D1. WVGA resolution is 800 × 480; D1 resolution is 704 × 576.
Device Type	Display device type.
Frame Rate	NTSC: 30 fps, PAL: 25 fps.
Reboot Date	On the set date, device will automatically reboot.
Sensitivity of fill light to open	Set threshold of light.
Version Info	Display device version info.
Default	Only restore current Local Config page to default settings.

4.1.1.2 A&C Manager

System Config | Local Config | AAC Manager | System Time | Config Manager

AAC Manager

Unlock Reasoning Interval: Door Sensor Check Time: Check Door Sensor Signal below Lock

Unlock Period:

Figure 4-2

Parameter	Note
Unlock Responding Interval	The interval between current unlock and next one, unit is second.
Unlock Period	Period door remains unlocked, unit is second.
Door Sensor Check Time	When only use door sensor, check "Check Door Sensor Signal Before Lock", Set "Door Sensor Check Time" to enable it.
Check Door Sens or Signal Before Lock	When door remains unlocked over set door sensor check time, it alarms.

4.1.1.3 System Time

Here you can set date format, time format, and input system date and time. You can also click on Sync PC to synchronize system time with PC time.

4.1.2 LAN Config

Here you can register VTO to center and set how to call center. Please refer to Ch 5.1.1.

4.1.3 Indoor Manager

In Indoor Manager interface, you can add VTH (digital indoor station), view VTH info and delete VTH.



Figure 4-3

Add VTH

In Indoor Manager interface, click on Add. The system pops up a window as in Figure 4- 4.

The 'Add' dialog box contains the following fields: Family Name, First Name, Nick Name, VTH Short No., and IP Address. There are 'OK' and 'Cancel' buttons at the bottom.

Figure 4-4

Fill in VTH info as user's name, VTH short no. and IP address.

Note:

VTH short no. consists of four digits, the first two digits can be within 01~99, the last two digits can be within 01~16.

Note:

Parameters with * are mandatory.

4.1.4 Network Config

Here you can set VTO IP address, Subnet Mask and Default Gateway.

After you have modified IP address, Web page will reboot and go to the new IP address web page. See Figure 4- 5.

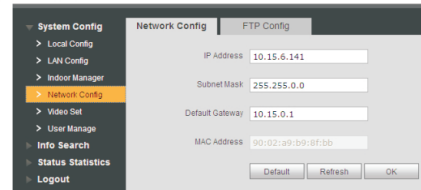

Figure 4-5

4.1.5 Video Set

You can set video effect and volume in Video Set interface. See Figure 4- 6.

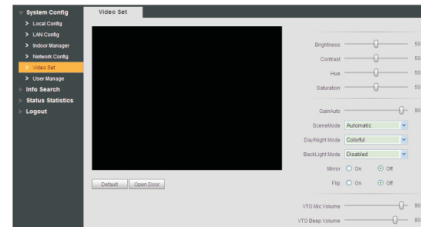



Figure 4-6

Parameter	Note
Gain	Gain limit of video basic parameter.
Scene Mode	Select mode: automatic, sunny, night and etc.
Day/Night Mode	Color mode.
Back Light Mode	Back light for special environment.
Mirror	Make image displayed in mirror.
Flip	Display image in flip.
VTO Mic Volume	Set VTO MIC volume size.
VTO Beep Volume	Set VTO beep volume size.
Default	Reset video effect and volume to default.
Unlock	Unlock via web.

4.1.6 User Manage

Only when you login as admin, you can add, modify, delete and view user info in User Manage interface.

● Add User

In User Manage interface, click on , system pops up Figure 4-7. Fill in user info.

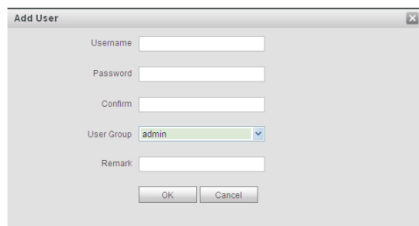

The 'Add User' dialog box contains the following fields: Username (text input), Password (password input), Confirm (password input), User Group (dropdown menu with 'admin' selected), and Remark (text input). There are 'OK' and 'Cancel' buttons at the bottom.

Figure 4-7

● Modify User

In User Manage interface, click on , system pops up Modify User interface. Check Change Password, and change password and remark, see Figure 4-8.

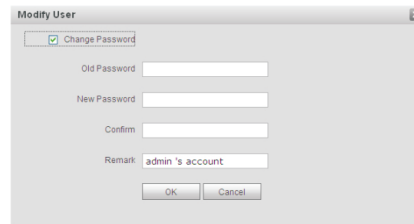

The 'Modify User' dialog box has a 'Change Password' checkbox which is checked. It includes fields for Old Password, New Password, Confirm, and Remark (with 'admin's account' entered). 'OK' and 'Cancel' buttons are at the bottom.

Figure 4-8

● Delete User

In User Manage interface, click on  to delete user.

4.2 Info Search

4.2.1 Call History

Here you can view call history of VTO in Call History interface. It can save up to 1024 items. See Figure 4-9.

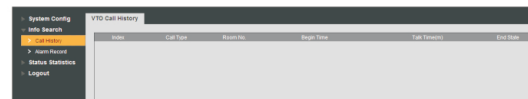

The 'VTO Call History' interface shows a table with columns: Index, Call Type, Reason No., Begin Time, Talk Time, and End Time. The table is currently empty.

Figure 4-9

4.2.2 Alarm Record

You can search VTO alarm record on Alarm Record interface with storage up to 1024 items. See Figure 4-10.



The 'Alarm Record' interface shows a table with columns: Index, Reason No., Event Date, Channel, and Begin Time. The table is currently empty.

Figure 4-10

4.3 Status Statistics

4.3.1 VTH Status

Here you can view connection status of VTH.

- **Delete User**

Offline: VTO and VTH are not connected, you cannot call, monitor, talk or etc.

Online: VTO and VTH are connected, you can call, monitor, talk and etc.

- MON
- Unmon: VTH is not monitoring.
- Onmom: VTH is monitoring.

See Figure 4- 11.



Figure 4–11

4.4 Logout

Here you can reboot device or logout.

Click on logout to log out the system and it returns to login page.

5 Basic Function Introduction

5.1 Call Function

5.1.1 Call Manager Center

Check Register to the MGT Center, you can touch the Call button to call manager center. Now VTO can only call MGT Center, cannot call VTH. Manager center's time can be set on management platform or villa VTO's web-end. Once manager center picks up the call, you can perform a visual bidirectional talk with the manager center. You can touch the button on VTO to end call at any time.

Step 1 According to VTO configured for the center, fill in building no, building unit no. and VTO no.

Step 2 In LAN Config, check register to the MGT center, as in Figure 5– 1.

Step 3 Fill in MGT center IP address and MGT port no.

Step 4 Set call VTS time. Within this period, VTO can only call the center.

Step 5 Check Call VTS or not.

Step 6 Confirm all config, and click on OK. Enter Logout Reboot Devices, to manually reboot the device.

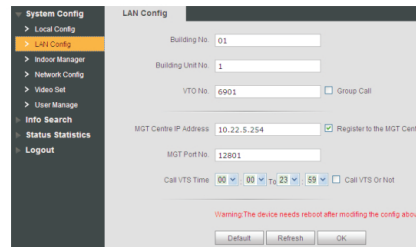

Figure 5– 1

5.1.2 Call User

Press Call button under standby status, and the VTO will call user. User may monitor VTO from VTH.

- On VTH, press Unlock button to unlock door.
- When VTH picks up, you can start talk with the VTH.
- If no one answers the call, then the call will end automatically and device returns to standby status.

5.1.3 Group Call

Group call is mainly used for one VTO. Press Call button on VTO to call multiple VTH at the same time.

VTH consists of master VTH and extension VTH. A system can only have a max of 1 master VTH and 5 extension VTHs. Please refer to VTO2000A Series Installation Guide V 1.0.0.

Set VTO

Step 1 Select System Config>Indoor Station Manager, system shows Indoor Station interface.

Step 2 In Indoor Station Manager interface, click on  to delete default VTH.

Step 3 Click on Add, input VTH Short No., IP Address (optional) to add a VTH. See Figure 5-2.

Note:

In Indoor Station interface, you only need to add main VTH, and you do not need to add extension.

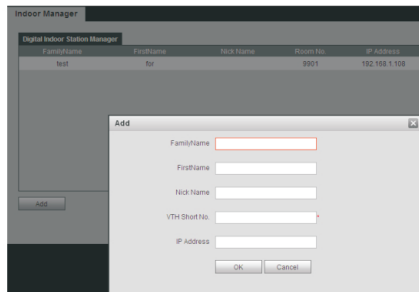

Figure 5-2

Note:

Parameter with * are mandatory to be set.

Step 4 In LAN Config interface, check Group Call, and click on OK. See Figure 5-3.

Step 5 After config is complete, enter Logout interface to reboot VTO.

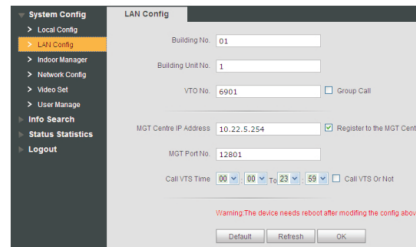

Figure 5-3

Set Main VTH

Step 1 On VTH screen, press System Settings>Project Settings, input password (default is 002236) to enter Project Settings interface.

Step 2 Press Product Info, input Room No., Local IP and etc as in Figure 5-4.

Note:

Room No. must match setting in VTH Short No. In Figure 5-4.



Figure 5-4

Step 4 Press Network, input VTO IP Address. See Figure 5– 5.

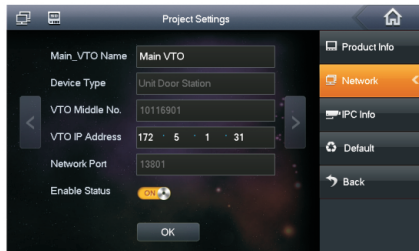

Figure 5–5

Set Extension

Step 1 On VTH screen, press System Settings>Project Settings, input password (default is 002236) to enter Project Settings interface.

Step 2 Press Product Info. Press Master, Master icon becomes Extension icon.

Step 3 Set Room No. (i.e. 1101–1), input IP Address, Subnet Mask and Gateway.

Step 4 In Master IP, input IP of the main VTH. After completion, extension will automatically sync with main VTH info configured by user. See Figure 5– 6.



Figure 5–6

5.2 Monitor

Both VTS and VTH are able to monitor this VTO by enabling the camera to capture local circumstance.

5.3 Unlock Function

Unlock by Center

When center is called, calling or monitoring, center can remotely unlock door. VTO will return to standby interface after call ends or countdown stops.

Unlock by VTH

When VTH is called, calling or monitoring, VTH can remotely unlock door. VTO will return to standby interface after call ends or countdown stops.

5.4 Compensation of Light

In dark environment or at night, the VTO adopts auto photoreception technology which achieves light compensation in connecting status.

5.5 Vandal Proof

There is one channel of vandal proof which will generate alarm sound and report to the manager center once VTO is forced to leave the wall.

5.6 Restore Backup

Restore Card Info

If you encounter abnormality with card info or accidentally restore default settings, you can restore card info with this function.

Restore VTH Info

If VTH info is mistakenly changed, you can restore VTH info with this function.

Note:

Every half hour, VTO automatically saves card and VTH info in the system. If you want to restore card and/or VTH info, you must restore within half hour after your last operation that change these info.

6

FAQ

1. Q: I pressed Call button, and the indicator turned on, but the VTO did not start a call?
A: Please check your operation process.
2. Q: How to end a call when I am calling?
A: Please press button on VTO and there will be sound from the device.
3. Q: The device could not boot up and there was no sound or light.
A: Please check if power supply is well plugged.
4. Q: My call did not go through.
A: It is network connection error; please check the cables of the device and its extension.
5. Q: I have other problems not included above.
A: Please contact technical staffs for assistance.

Appendix 1 Technical Specifications

Model		VTO2000A-2
System	Main Process	Embedded micro controller
	OS	Embedded Linux os
Video	Video Compression Standard	H.264
	Input/Sensor	Megapixel CMOS HD camera
	Night Vision	Support
Audio	Input	Omnidirectional Mic
	Output	Built-in speaker
	Talk	Support bidirectional talk
Operation Mode	Input	Single key input
	Door Lock Status Check	Support (optional)
Network	Ethernet	10M/100Mbps self-fit
	Network Protocol	TCP/IP
General	Power	DC 24V
	Consumption	Standby $\leq 1W$; working $\leq 7W$
	Working Temperature	-30°C ~ +60°C
	Relative Humidity	10% ~ 90%RH
	Dimension (L x W x H)	129.9mm x 32.2mm x 140mm
Weight	0.8kg	

Appendix 2 Technical Specifications

Appendix 2.1 Cable Specification

The wiring length between VTO and VTH is L_N, so reasonable specification of wiring is:

Cable Specification	0 < L _N ≤ 50m	50 < L _N ≤ 100m
UTP Cat5e/Cat6: 10 ohm/100m	Optional	Optional
UTP Cat5e/Cat6: 18.8 ohm/100m	Not optional	Not optional

Note:

Please do not let L_N be over 100m.

Appendix 2.2 Power Extension Line Specification

The wiring length between VTO and adaptor is L_c, so reasonable specification of extension line is:

Extension Line Specification	0 < L _c ≤ 30m	30 < L _c ≤ 100m
20AWG	Optional	Not optional
18AWG	Optional	Optional
17AWG	Optional	Optional

Note:

Before plugging extension line to power, make sure its positive and negative end are correctly wired.

Appendix 2.3 Embedded Box

VTO Model	Embedded Box
VTO2000A-2	Case 126*115

Appendix 3 VTMS

● Check Installation Environment

This manual makes Window XP as example to introduce how to modify IP of PC inorder to connect VTMS and monitoring system.

Step 1 Select Start>Control Panel>Network Connection>Local Area Connection, right click on Local Area Connection icem, select Properties. see Appendix 3- 1.

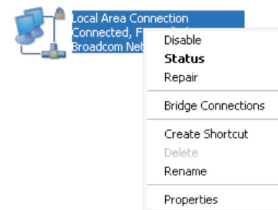

Appendix 3-1

Step 2 View and modify IP address, make it in the same segment with VTO. See Appendix 3- 2.

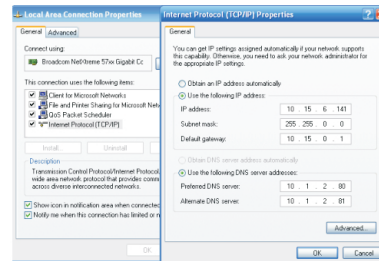

Appendix 3-2

- Step 3** After complete modification, select Start>Run, input "cmd" , click on OK. Enter command interface, input "ping" + IP of the VTO. If it obtains communication data, then VTO and the PC are connected. See Appendix 3-3.

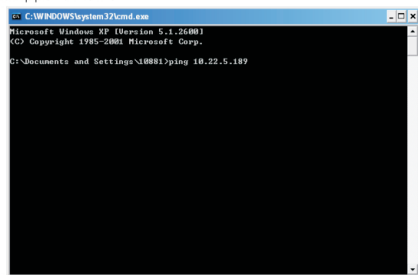

Appendix 3-3

● Enable VTMS

The following mainly introduces how to config VTMS for you to login VTO and use VTMS.

- Step 1** Install VTMS on PC.



- Step 2** Double click on , click on **vt_guard...** , Start service, and VTMS will boot up.

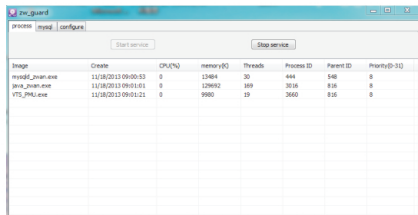

Appendix 3-4

Appendix 4 VTMS Client

This following mainly introduces how to config VTMS Client.

Appendix 4.1 Config Network Address

- Step 1** Install VTMS Client on PC.

- Step 2** Double click on  , in pop-up box input username, password, IP address, port and etc. Click on Login. See Appendix 4-1.

Note:

Default username and password is admin and 123, respectively. After first successful login, please change password.

Vision Telephone Manage System

name:

pwd:

ip: port:

auto login save pwd

Appendix 4-1

- Step 3** In main interface, click on Device MGR. See Appendix 4-2.

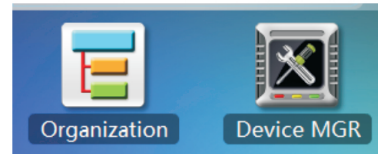

Appendix 4-2

Step 4 Double click on VTS parameter column, system pops up Edit device box, input PC's IP address. See Appendix 4-3.

Appendix 4-3

Step 5 Click on Save. Input project password (default project password is 123).

Step 6 Re-login VTMS, you can see VTMS is successfully configured as in Appendix 4-4.

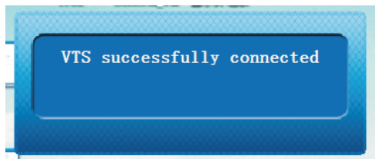

Appendix 4-4

Appendix 4.2 Create Organization

First you must build up environment and set VTMS server, please refer to Appendix 3. This chapter takes example of a residence with 10 buildings and 2 units.

● Create Residence Organization

Step 1 In VTMS main interface, select Organization, click on Batch Add. System pops up Batch Add box, see Appendix 4-5.

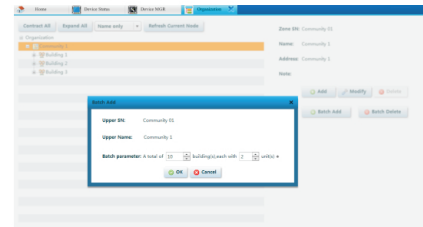

Appendix 4-5

Step 2 Click on OK to save. The created organization is as in Appendix 4-6.

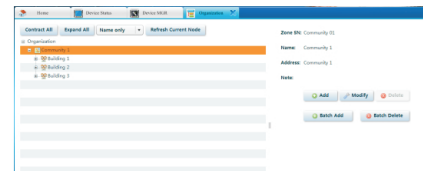

Appendix 4-6

● Add VTO

Step 1 In VTMS main interface, select Device MGR, click on Add, system pops up Batch Add box.

Step 2 Fill in info according to your actual condition, and click on Save. See Appendix 4-7.

Appendix 4-7

● Add VTH

Step 1 In VMS main interface, select Device MGR, click on Batch Add, system pops up Batch Add box.

Step 2 Fill in info according to your actual condition, and click on Save. See Appendix 4-8.

Appendix 4-8

Appendix 5 Toxic or Hazardous Materials or Elements

Component Name	Toxic or Hazardous Materials or Elements					
	Pb	Hg	Cd	Cr VI	PBB	PBDE
Circuit Board Component	○	○	○	○	○	○
Device Case	○	○	○	○	○	○
Wire and Cable	○	○	○	○	○	○
Packing Components	○	○	○	○	○	○
Accessories	○	○	○	○	○	○

O: Indicates that the concentration of the hazardous substance in all homogeneous materials in the parts is below the relevant threshold of the SJ/T11363-2006 standard.

X: Indicates that the concentration of the hazardous substance of at least one of all homogeneous materials in the parts is above the relevant threshold of the SJ/T11363-2006 standard. During the environmental-friendly use period (EFUP) period, the toxic or hazardous substance or elements contained in products will not leak or mutate so that the use of these (substances or elements) will not result in any severe environmental pollution, any bodily injury or damage to any assets. The consumer is not authorized to process such kind of substances or elements, please return to the corresponding local authorities to process according to your local government statutes.

Note

- For detailed operation introduction, please refer to our resource CD included in your package for electronic version of the User's Manual.
- Slight difference may be found in user interface.
- All the designs and software here are subject to change without prior written notice.
- All trademarks and registered trademarks mentioned are the properties of their respective owners.
- If there is any uncertainty or controversy, please refer to the final explanation of us.
- Please visit our website for more information.